

Table of Contents

Section 1	Introduction	3
Section 2	Type designation system	4
Section 3	Installation	5
3.1	Main features	5
3.2	Suspension instructions	6
3.3	Connection of load	6
3.4	Brake installation	6
3.5	Motor installation	6
3.6	Operation limits and end of stroke limit switches	7
3.7	Installation of motor bracket p/n D800 264 and gear BS40 on unit MGZ2K3220	8
3.8	Suspension of MovoZ Z2 with suspension frame p/n D800 250	8
3.9	Installation of service lock p/n D800 072	9
3.10	Adjustment of magnet sensor	9
Section 4	Service and maintenance	10
4.1	General maintenance instructions	10
4.2	Lubrication	10
Section 5	Technical data	11
5.1	Technical data	11
5.2	Maximum permissible speed	11

Section 1 Introduction

MovoZ Z2 is a telescopic actuator used in lifting applications. It consists of three extruded aluminium profiles which is run in and out of each other with the aid of a ball screw. Slide bushings are mounted between the profiles. A motor with a brake or a motor and a separate brake is mounted in the end of the unit while the load is installed in the plate in the other end of the unit.

Do not hesitate to contact Tollo Linear if you have any questions regarding installation or service. State the manufacturing number and the type designation of the unit, see point 3.1, in such case.

Important!

- Read through this manual before beginning the installation or servicing and follow all applicable directions in order to ensure a safe and proper job.
- In order to ensure a long life expectancy and reliable functionality, MovoZ Z2 must be serviced according to the directions found in this manual. Spare parts should be by the same manufacturer and of the same type as the original or be among those approved in writing by Tollo Linear. Never use parts which work improperly or seems damaged.
- The system or machine part of which MovoZ Z2 is a component must not be used before it is in compliance with the EU's Machinery Directive in those instances where it is to be used within the EEC area.
- If possible, never work with power, compressed air or hydraulics turned on. If the work must be performed with some of these turned on, another person must be positioned so that the power, compressed air or hydraulics can be turned off in the event of any mishap.

Section 2 Type designation system

M	G	Z2	K	25	10	9	-
Metric.....M	Slide bushings.....G	Profile sizeZ2	Ball screw + ball nutK	Type of ball screw, diameter / lead / tolerance class					
				25 mm / 10 mm / T9.....	25.....	10.....	9		
				25 mm / 25 mm / T9.....	25.....	25.....	9		
				32 mm / 20 mm / T7.....	32.....	20.....	7		
				Hyphen.....			-		
				Lmin. (min. retracted length in cm).....			000 – 999		
				Lmax. (max. extended length in cm).....			000 – 999		

Table 1: Type designations

3.2 Suspension instructions

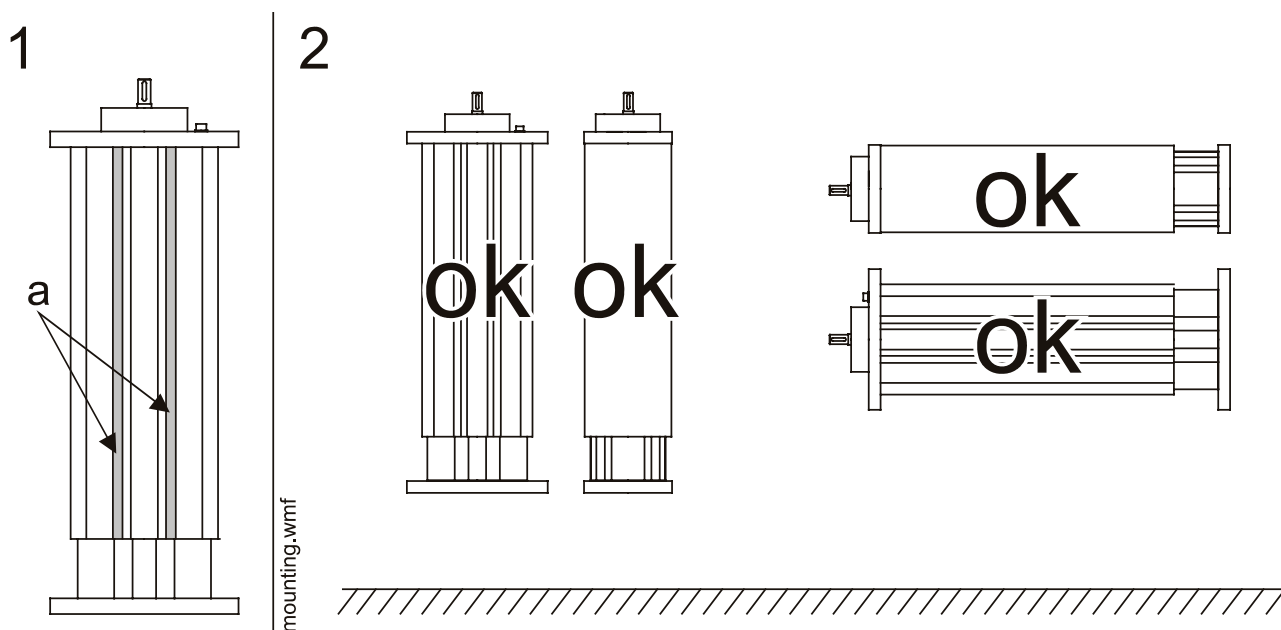

Figure 2: Suspension instructions

1. MovoZ Z3 is suspended in the T-slots (a).
2. MovoZ Z2 can be suspended in any position (vertically, horizontally or inclined).

3.3 Connection of load

Connect the load to the load attachment plate, see point 3.1. Do not exceed the max. permissible load or the max. permissible load torque. Always try to mount the load in the centre of the unit in order to minimise the load torque thus increasing the life of the unit.

3.4 Brake installation

Important !

As MovoZ Z2 is not self-braking the load attachment plate and the load immediately will fall down if the driving force is disconnected. This means that MovoZ Z2 must be equipped with an electrically released brake that can hold the load. This brake can be integrated in the motor or be mounted separately.

3.5 Motor installation

On MovoZ Z2 units of type MGZ2K2510 and MGZ2K2525 the gear box or the intermediate flange for the motor is installed directly to the holes around the drive shaft. On units of type MGZ2K3220 a floating suspension method must be used which demands the use of a torque absorbing bracket in which the gear box or the intermediate flange can be installed so that no side torque is transmitted to the drive shaft. Such motor bracket, suitable for gearboxes of type BS40, is available from Tollo Linear. Also see point 3.7.

3.6 Operation limits and end of stroke limit switches

1

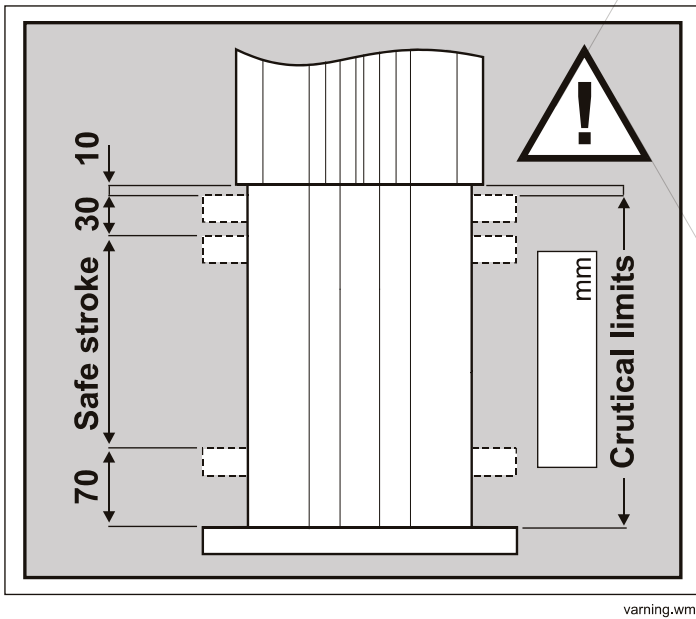

2

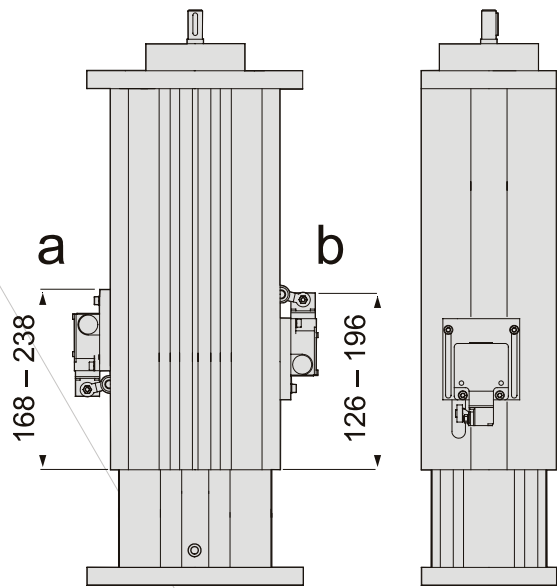

Figure 3: Operation limits

1. The recommended operation stroke is "Safe stroke". If the unit is run outside of "Critical limits" the unit will collide with its mechanical end positions and become damaged. Note! Keep in mind that the length of the distance to stop ultimately depends on the speed and the deceleration the drive system is set to.
2. The unit is equipped with two adjustable end of stroke limit switches, one for the lower end of stroke (a) and one for the upper (b). Both limit switches can be adjusted 70 mm from the lower/upper mechanical end of stroke positions.

3.7 Installation of motor bracket p/n D800 264 and gear BS40 on unit MGZ2K3220

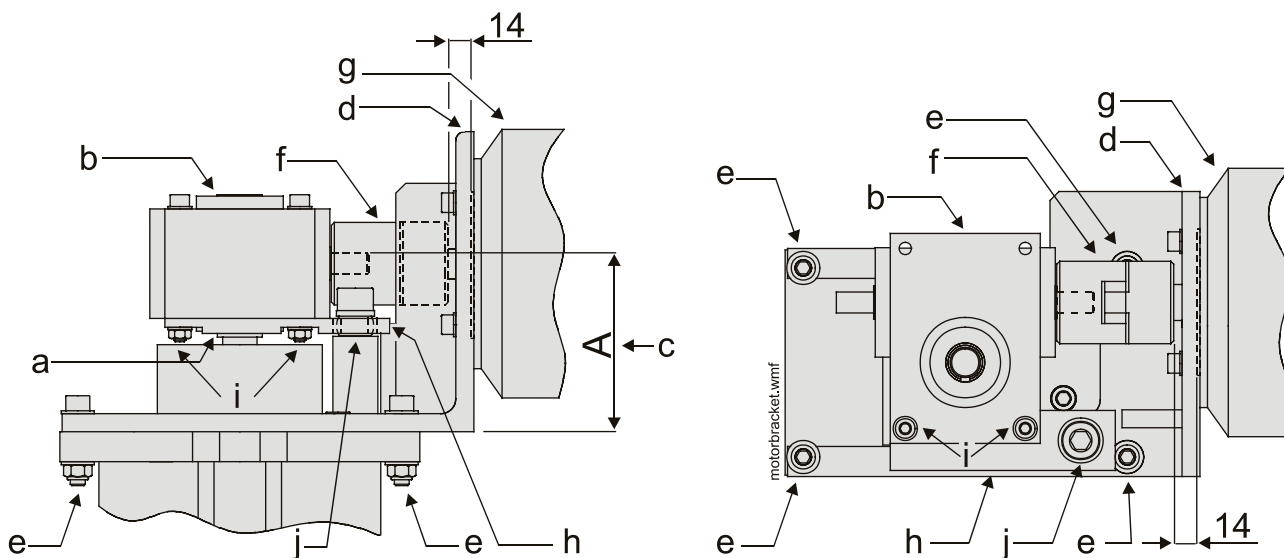

Figure 4: Installation of motor bracket

1. Mount the spacer washer (a) on the drive shaft of the unit and then place the gearbox (b) on the drive shaft.
2. Measure the distance (c) between the top of the upper plate and the top of the input shaft of the gearbox (distance A). Reduce the distance A with 118,3 mm = final value.
3. Place shims at the attachment holes on the upper plate of the unit corresponding to the final value and then attach the motor bracket (d) to the plate using the four screws (e). Do not tighten the screws fully.
4. Fit the coupling (f) to the shaft of the motor and the gearbox. Check so that the coupling on the motor shaft is positioned 14 mm from the motor.
5. Attach the motor (g) to the motor bracket (d).
6. Tighten the screws of the motor bracket (e).
7. Mount the torque bar (h) to the gear box with the aid of the two screws (i). Do not tighten the screws fully.
8. Place the link bearing (j) in the torque bar and bolt it to the motor bracket.
9. Tighten the screws (i) between the gearbox and the torque bar.
10. Fit the protective cover (not shown) over the coupling.

3.8 Suspension of MovoZ Z2 with suspension frame p/n D800 250

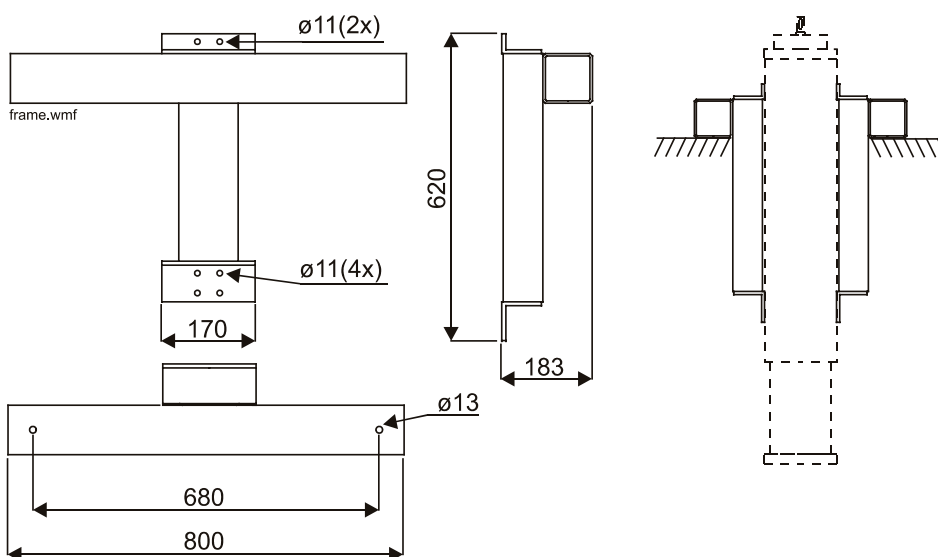

Figure 5: Suspension frame

3.9 Installation of service lock p/n D800 072

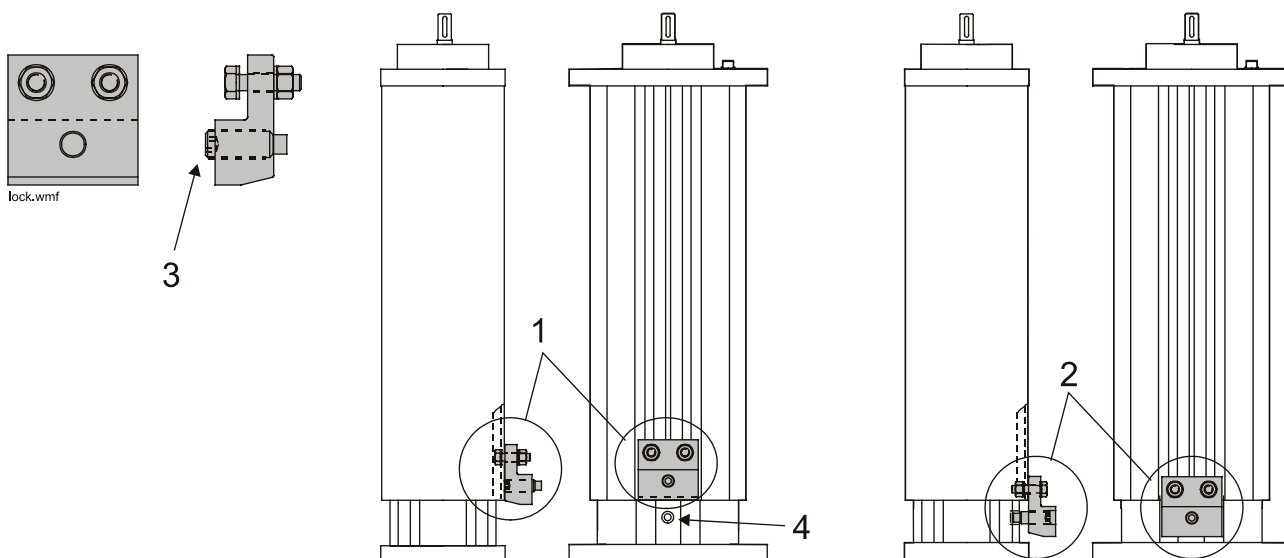
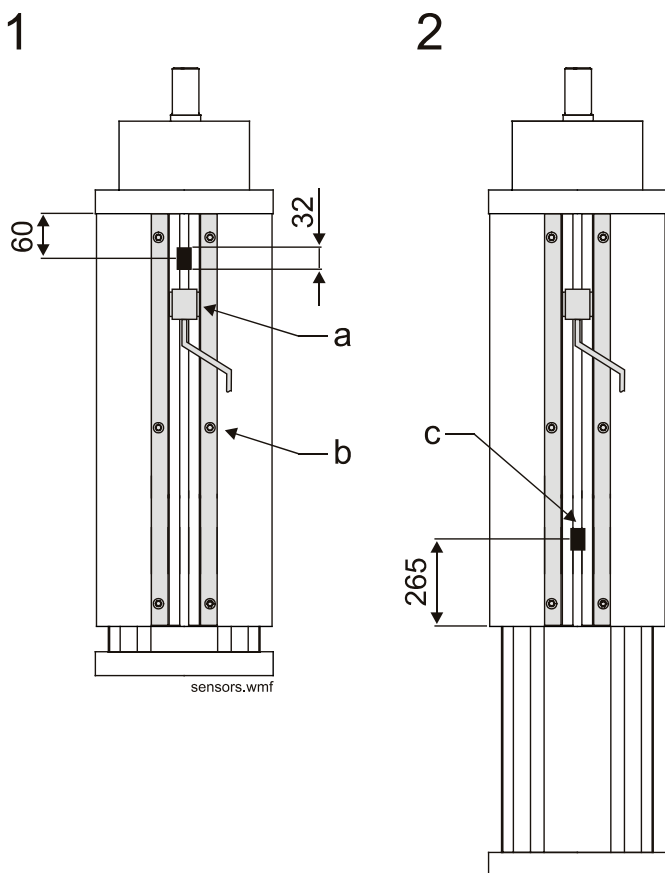

Figure 6: Service lock

The service lock is used to lock the profiles in connection to service when the brake needs to be detached. When the lock is not being used it is mounted with the flat side against the profile (1) with the aid of the T-slots in the profile. When it is used the lock is turned around (2) and mounted so that the lock pin (3) can be screwed in to the lock hole (4) and thereby lock all profiles.

3.10 Adjustment of magnet sensor



The magnet sensors are attached to the unit by means of the sensor rails (p/n D800 223). How the rails are installed is described in the instruction supplied with the sensors.

To be able to adjust a sensor (a) the fixing screws (b) of the rails must be loosened. The magnet (c), which triggers the sensors, is 32 mm long and its centre is located 60 mm from the top when the unit is fully retracted.

Keep in mind that the duration of the time when the sensor is leaving a signal is dependent on the speed of the unit and the length of the magnet. This means that the relay or input, which shall detect the signal, must be able to react on a signal with the duration in question.

1. Magnet position at fully retracted unit
2. Magnet position at fully extended unit

Figure 7: Magnet sensor

Section 4 Service and maintenance

4.1 General maintenance instructions

- The customer can perform the service and maintenance described in this manual. Other service ought to be performed by service personnel from Tollo Linear, either on-site or at a Tollo Linear Service Centre.
- Follow the recommended service intervals. Replace defective parts immediately. Only use parts of the same make and type as original. Ordering data can be found in the spare part lists supplied with the unit. Also state the manufacturing number of the unit (embossed in the drive end).
- Movoz2 is not self-braking. This means that the load attachment plate and the load immediately fall down to the lowest position if the brake is detached. Ensure therefore that the unit is secured or is placed horizontally before the brake is detached.
- Check the unit in connection to lubrication. Particularly check for play between the outer, middle and inner profile (slide bushing wear), the function of the position indicators, the suspensions and the connection of the load. Also be attentive towards a changed level of noise. Replace, repair or adjust.
- Keep Movoz Z2 clean. Wipe it off as required, particularly the sliding surfaces. If cleaning fluid is required, use small amounts and see to it that none gets into Movoz Z2, do not use strong cleaning agents. Dry it fully.
- **Never** mix different types of oils / lubricants!

4.2 Lubrication

1. Lubrication of sliding surfaces

The sliding surfaces (totally 8) where the slide bushings slides must **always** be covered by a thin layer of oil of type Klüber GLY2100. Lubricate when necessary.

2. Lubrication of ball screw

The ball screw is lubricated trough the lubrication hole. Run the unit until the screw becomes visible. Lubricate with grease of type Klüber Starburags NBU30. The lubrication intervals is determined by the maximum load and the load torque the unit is subjected to, see the table below.

Note! Never put the fingers in to the lubrication hole.

Max. load	Lubrication interval
0 – 250 kg	every 700 hour of operation
251 – 750 kg	every 350 hour of operation

Table 2: Lubrication interval for ball screw

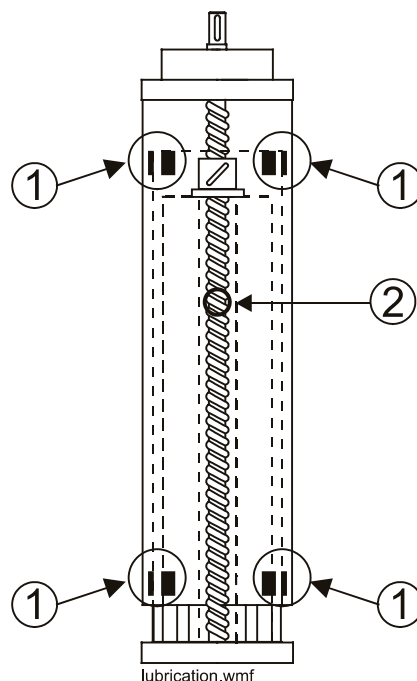

Figure 8: Lubrication

Section 5 Technical data

5.1 Technical data

MovoZ Z2		MGZ2K2510	MGZ2K2525	MGZ2K3220
Max. speed	(m/s)	0,5 ^A	1,0 ^A	0,8 ^A
Max. load	Fz (kg)	500	500	750
Max. load torque	Mx/My (Nm)	700	700	700
Repeatability	(mm)	± 0,1	± 0,1	± 0,1
Ambient temperature	(°C)	-20 – +70	-20 – +70	-20 – +70
Linear move / shaft rev.	(mm)	10	25	20
Max. input speed	(rpm)	3000	2400	3000
Weight	(kg)	9,5 + 0,25 × Lmin. ^B	9,5 + 0,25 × Lmin. ^B	13 + 0,28 × Lmin. ^B

^A See diagram 1 below ^B L in cm, see figure 1

Table 3: Technical data

5.2 Maximum permissible speed

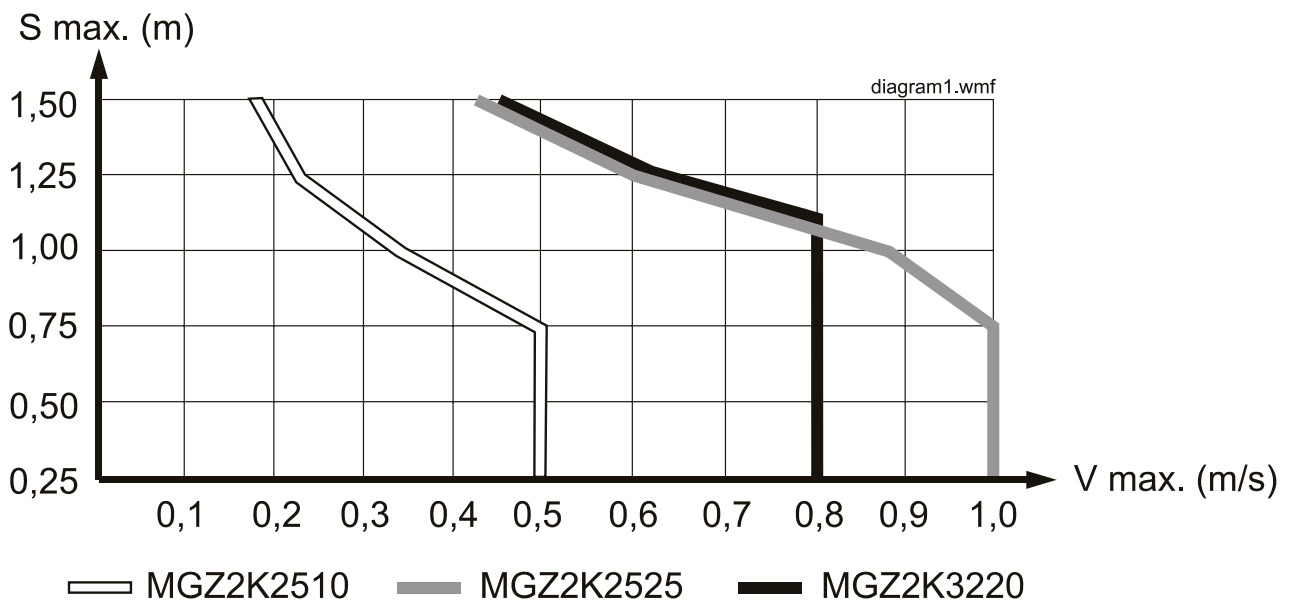

Diagram 1: Maximum permissible speed (V max.) as a function of the maximum stroke (S max.)

www.LinearActuators.com

OFFICES

France

Danaher Motion S.A.S.
C.P. 80018
12, Rue Antoine Becquerel - Z.I. Sud
Bâtiment Paul Tiger 2
F-72026 Le Mans Cedex 2
Tel. +33 (02) 43 50 03 30
Fax. +33 (02) 43 50 03 39

Germany

Danaher Motion
Postfach 2008
D-72610 Nürtingen
Tel. 0180 5 24 67 90
Fax. 0180 5 24 40 85

Spain

Danaher Motion
Badal, 29–31 7th, 1st
08014 Barcelona
Tel./Fax. +34 (0) 9329 80278

Sweden

Tollo Linear AB
Box 9053
SE-291 09 Kristianstad
Tel. +46 (0)44 24 67 00
Fax. +46 (0)44 24 40 85

United Kingdom

Danaher Motion
Fishleigh Road
Roundswell Business Park
Barnstaple, Devon
EX31 3UD
Tel. +44 (0) 1271 334500
Fax +44 (0) 1271 334502

PUBLISHER

Tollo Linear AB

Box 9053
SE-291 09 Kristianstad, Sweden
Internet www.tollo.com
E-mail helpdesk@tollo.com

BRANDS

**Thomson
Thomson Tollo
Micron
Deltran PT**



Vi förbehåller oss rätten till ändringar
We reserve the right to make changes
Änderungen vorbehalten
Tous droits de modification réservés